

Installation & User Manual
For
MultiCOM
Cellular Intercom System
(2 relay version)
Version 3

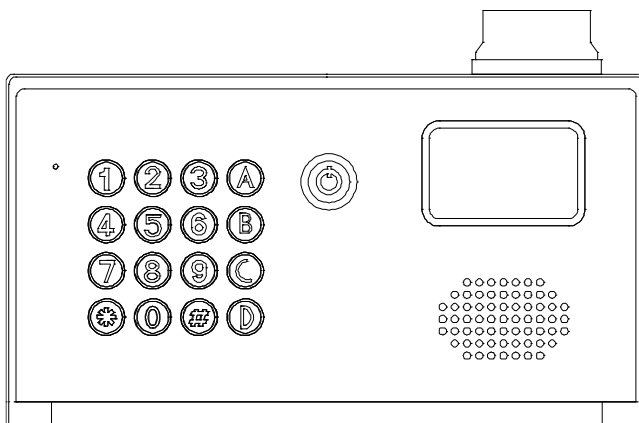

BFT Americas

6100 Broken Sound Parkway N.W. Suite 14, Boca Raton, FL 33487



www.bft-usa.com

Toll Free: 877-995-8155

Office: 561-995-8155

Fax: 561-995-8160

Contents

Overview of systemPg 3
Site SurveyPg 3
SIM cardPg 3
PowerPg 3
Call Box OverviewPg 4
MountingPg 4
Inserting the SIM CardPg 4
WiringPg 5
Powering upPg 5
ProgrammingPg 5
Programming by Keypad & LCDPg 5
SMS ProgrammingPg 12
PC ProgrammingPg 14
Using the IntercomPg 17
Control by SMSPg 18
Door Release by Using the KeypadPg 18
Using the Optional AppPg 19
Android App SetupPg 19
Using Android AppPg 19
Using iPhone AppPg 20
Maintenance of the IntercomPg 21
TroubleshootingPg 21
Change HistoryPg 23

Overview of System

Please read this entire manual before attempting to install this system.

This system should only be installed by a professional automatic gate installer or access control specialist dealer.

It is recommended that the system be set up, configured, commissioned and tested on a workshop bench **before** taken to site for installation.

Site Survey

Before installing this system, you need to be sure that there is good mobile GSM cell coverage in the area it is to be installed. It is recommended that you conduct a site survey, and check reception on the site for a GSM network. If reception is poor in the area, then this system is not recommended. This unit can operate on At&T and T-Mobile networks in the USA.

SIM Card

You will need a SIM card in order to use this system. It should be a regular voice and SMS text SIM card. Do not use a data only SIM, as this is only for tablets and will not work in the unit.

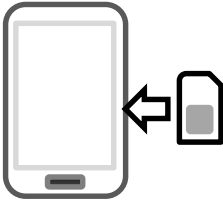

- 1) Ensure the SIM has calling credit, and can make and receive calls on a cell phone.
- 2) Check that the SIM is not locked to a phone and can be used in other devices. Call the service provider to unlock it if required.
- 3) Check that the SIM does not have a PIN code request.
- 4) You are now ready to begin programming.

Power

This system comes with a 24v d.c. power supply. It is recommended that it is located within 25 feet of the intercom and cabled in 14 gauge cable.

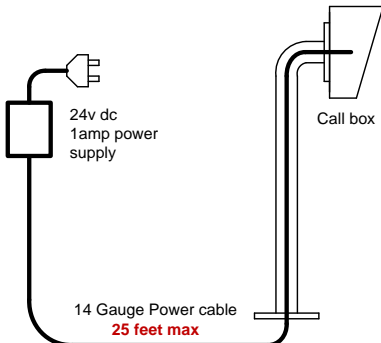

Tip: This device uses peak currents of up to 2 amps. For longer cable runs, 18 gauge will not run the unit and cause operational problems.



- 0-2m (0-6ft) use min 0.75mm (18 gauge).
- 2-4m (6-12ft) use min 1.0mm (16 gauge).
- 4-8m (12-24ft) use min 1.5mm (14 gauge).

Call Box Overview

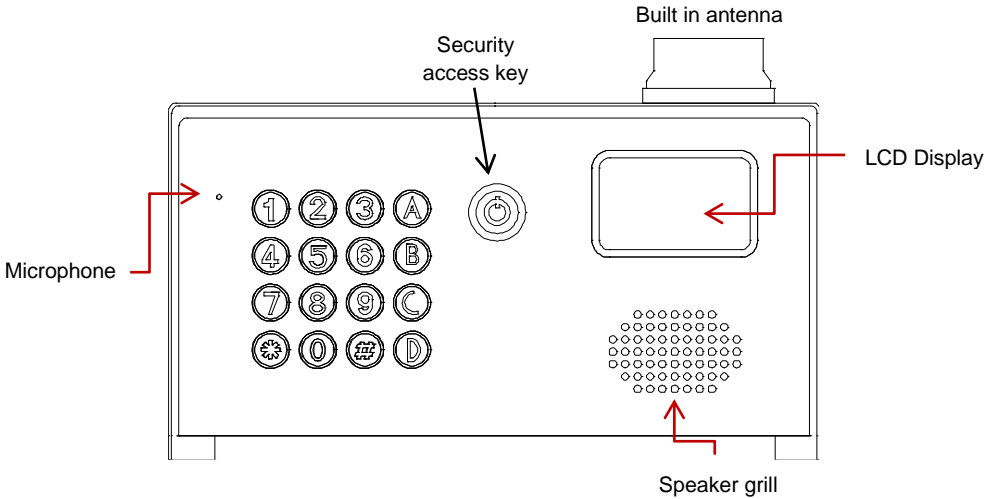

Tip: Keep all protective covers and films on the unit until fully installed. These covers are to protect the unit from scratches during installation.

Mounting

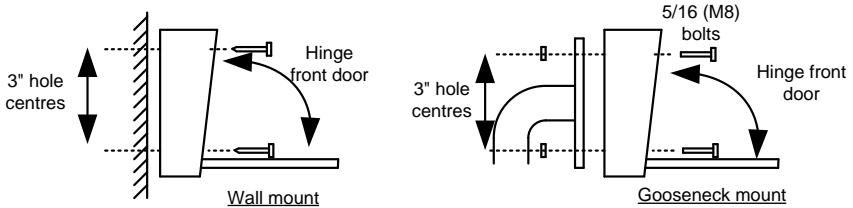

Inserting the SIM card

Note: This unit is a dual 2G/3G system, operating on either 2G or 3G network frequencies of 850/900/1800/1900MHz.



Please ensure the SIM card is a 2G/3G compatible SIM card. Do not use a SIM card for a tablet, as these only support data, and do not support voice and SMS. You simply require a mobile phone type SIM card.

- 1) Put the SIM into a phone to activate and register it with the network.
- 2) If you are using pay and go, top up the SIM with some airtime credit.
- 3) Test that the SIM can make and receive calls and can send and receive a SMS.
- 4) Ensure the power is OFF.
- 5) Slide the SIM card holder in the open direction, and carefully open the door. Do NOT force it.

Wiring

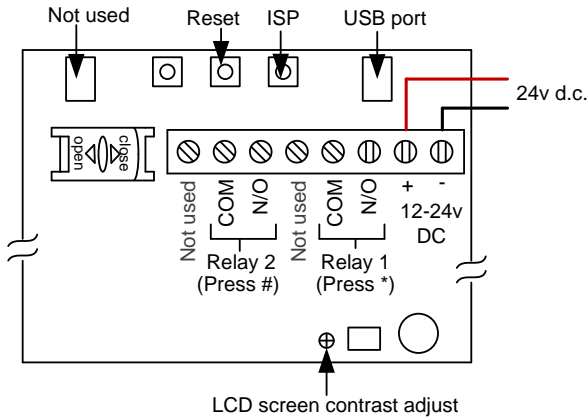

Powering Up

Perform a final check of wiring and ensure the antenna is connected before switching on the power. Once the power is switched on, the unit should boot up, display the firmware version on screen and then display the user screen.

Programming

There are 3 methods to program this unit...

1. By entering information on the keypad and LCD display on the device.
2. By sending SMS text messages.
3. By PC programming software with USB link.

Keypad & LCD Programming

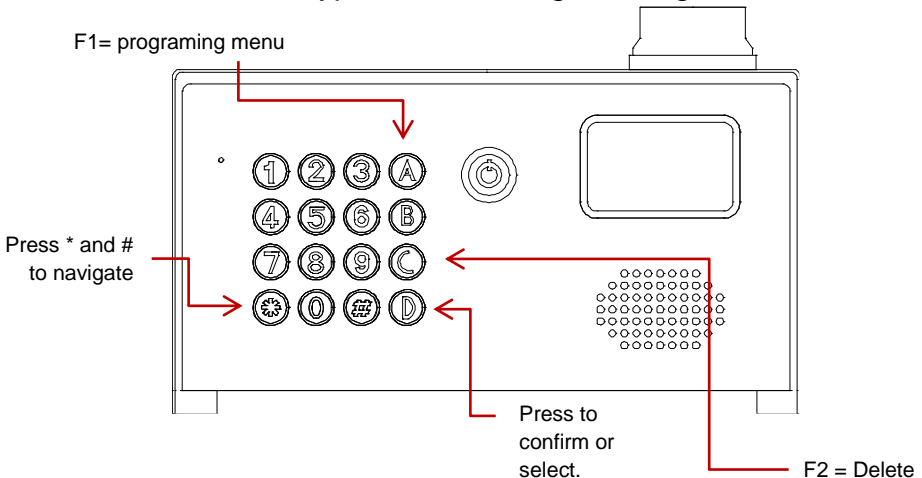

Enter Programming Mode

Hello Manager!

Password: *■

Press A to display the manager screen, enter the manager password and press the D button.

Note: The default password is 123456.



:Select/Save

F1 :Menu/Exit

F2 :Delete

***/# :Move Cursor**

This information screen will be displayed, and automatically will revert to the main menu after 20 seconds.

However, you can press A at any time to display the main menu immediately.

Manager
Subscriber
Sub-Menu
Authorized

Press * or # to move the cursor up and down and press D to select the option you require.

Press A to escape or go up one level.

Manager Programming parameters

System Settings

Change Password

Manager / System settings / Change password

Change password

New

Confirm

Use this to change the default programming password from 123456.

Manager Phone

Manager / System settings / Manager Phone

Manager phone

Should you wish to have a building manager, reception or security guard receive calls from the intercom, you may enter their number here.

Talking time

Manager / System settings / Talking time

Talking time

030 **Seconds**

This is the maximum conversation time which can be had when the call is answered. It is recommended to keep this to a minimum in order to minimise billing charges.

Greetings

Manager / System settings / Greetings

Greetings : 1

**Enter Flat Number
Then CALL**

This screen allows the installer to change the greeting message on the LCD screen. There are 2 standard messages to choose from and also a custom message can be written with option 3.
Note: Press * and # to move cursor. 0 for space, B to delete.

Volume Settings

Microphone Volume

Manager / Volume Settings / Mic. Volume



Adjust microphone volume from 1-9. Note that in some circumstances the microphone sensitivity may need adjusted. For example, if it is set too high, the intercom may experience acoustic feedback squelch. If it is too low, the phone user may have difficulty hearing the visitor. Please adjust accordingly.

Speaker Volume

Manager / Volume Settings / Speaker Volume



Adjust speaker volume from 1-8. It is recommended to set the speaker volume at the minimum acceptable level to avoid potential acoustic feedback.

Door Settings

Open by Password

Manager / Door Settings / Open by Password

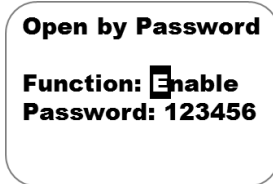

This is a master password which can be used to open the door, usually used by the manager. It is recommended that this master password be changed for security purposes.

Note: This feature MUST be enabled even to allow individual users to activate relays with their private codes.

Caller ID Open

Manager / Door Settings / Caller ID Open

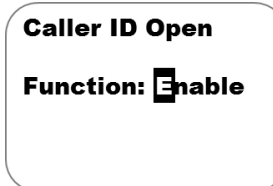

Enable this feature to allow stored phone numbers to be able to call the intercom and automatically trigger relay 1. When the stored number calls the intercom, it will trigger the relay and end the call without answering.

Note: For US customers, subscriber phone numbers may need to be stored with the long distance 1 prefix at the beginning of the number.

Door Open Time

Manager / Door Settings / Door Open Time

Door Open Time

03 Seconds

Adjust the relay trigger time. 1 second is sufficient for automatic gates. Certain door locks such as magnetic locks may require up to 5 seconds. Both relays will be set for the same time.

Door Relay Type

Manager / Door Settings / Door Relay Type

Door Relay Type

Normally Open

The relays can be set to normally open (usually for gate automation systems or strike locks, and normally closed (usually for magnetic locks).

Calling Settings

Door Calling Time

Manager / Calling Settings / Calling Time

Calling time

025 Seconds

IMPORTANT: Calling time is the time the intercom will spend calling a number before ending that call attempt and dialling the next number. Adjust this time to avoid voice mail boxes from picking up the call and thus preventing it from calling the next number.

Calling by List

Manager / Calling Settings / Calling by List

Calling by List

OFF

This enables or disables the scroll feature. For some applications, users wish visitors to be able to scroll names on the LCD display and select the appropriate resident to call. However for some applications, privacy may require that resident names are not displayed. Enable or disable this feature accordingly.

Incoming Call

Manager / Calling Settings / Calling by List

Incoming Call

Ringer: **OFF**

Enable ringer tone when the intercom is receiving a call from any phone. This may be useful to determine if a call is being made to the intercom for diagnostic or installation purposes.

Subscriber

Enter Subscriber

ID: 1 _____

Add? **No** **Yes**

500 residents can be added to the intercom under the subscriber feature. Enter the apartment, flat or house number as shown, and select YES to add that subscriber.

The screen below shows all the information which can be entered for a resident.

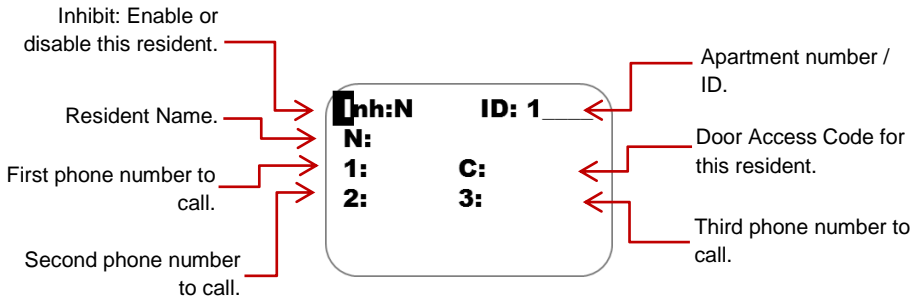

Tip: For US customers, you may need to enter the numbers with the long distance 1 prefix at the beginning of the number. This is to allow caller ID functions to work. Please try with and without the 1 and check which works.

Sub-Menu

SMS Setting: Setting by SMS: **ON/OFF** (On by Default)

Clock Setup: Set Clock: Set clock Time and Date

Authorized

Enter Authorized

ID:

Add **N** **o** **Yes**

100 Authorized users can be added to the intercom under this feature. Enter the apartment, flat or house number as shown, and select YES to add a user who is not a resident of that ID but who will be allowed entry under their authorization

The screen below shows all the information which can be entered for an authorized user.

Inhibit: Enable or disable this resident.

Resident Name.

Phone Number to Allow Entry.

Authorized Door Access Code

Apartment Number / ID.

Inh: **N** **ID:**

N:

I:

C:

Tip: For US customers, you may need to enter the numbers with the long distance 1 prefix at the beginning of the number. This is to allow caller ID functions to work. Please try with and without the 1 and check which works.

SMS Programming

The basic intercom features can be programmed by SMS. To do this, SMS text messages can be sent from a mobile cell phone.

Each message must begin with a pass code, then the function command, then the data. Each of these are separated by a # key as follows...

Passcode#command#data#

Enter a new subscriber / resident

Passcode#20#ID,name,telnumber1,telnumber2,telnumber3,doorcode,0#

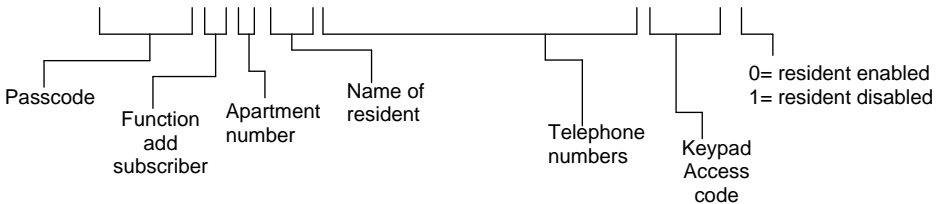

TIP: If you wish to leave a piece of data blank, for example for only entering one or two numbers and not all three, simply leave that section blank between the commas. Subscriber name max 15 characters.

Change a Subscriber / resident

Passcode#21#ID,name,telnumber1,telnumber2,telnumber3,doorcode,0#

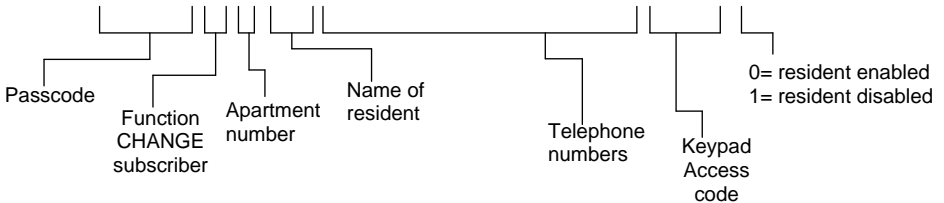

Delete a Subscriber / resident

Passcode#22#ID#

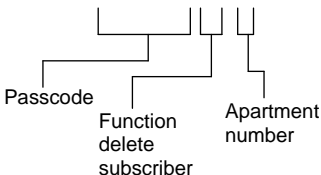

Additional SMS commands are shown below (SMS format assumes the standard default 123456 manager code has not been changed. If it has, replace this with the new code.

Description	Format of SMS	Comment	Default
Change passcode	123456#02#newcode#	6 digit code	N/A
Set managers phone number	123456#03#phonenumber#		N/A
Set talking time	123456#09#?#	? = minutes, 1-99.	3 mins
Set door open by password	123456#12#1#password#	1 = enable, 0 = disable	N/A
Set door open time	123456#13#?#	? = seconds, (2-99 sec)	3 secs
Set door relay type	123456#14#?#	0 = N/O, 1 = N/C	0 (N/O)
Set calling time	123456#15#??#	?? = seconds (25-99)	25
Calling list enable / disable	123456#16#?#	0=disabled, 1=enabled	0
Enquire subscriber	123456#23#?#	? = apartment address	N/A

Programming by PC

To program the unit by windows PC, first install the PC programming tool. Then power up the unit with SIM card inserted. Finally connect the USB cable to the USB port beside the power terminals and open the software.

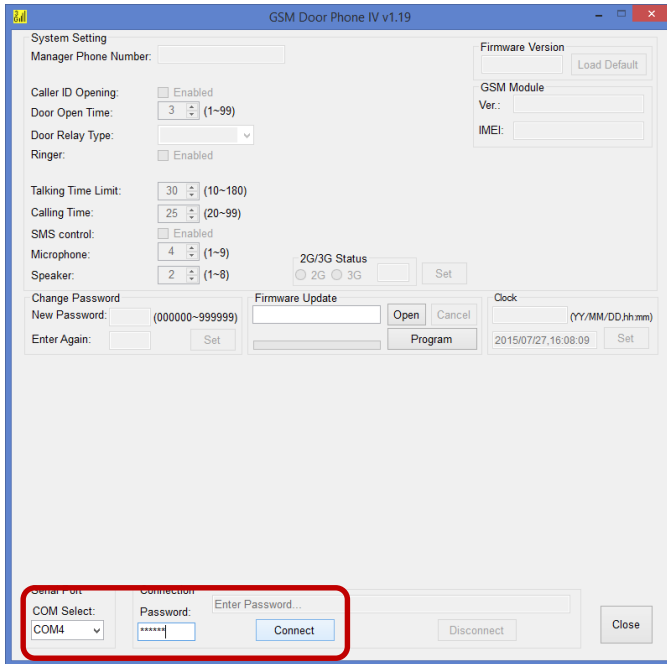

The window above will appear. Select each COM port option shown bottom right until an error message does not appear (this will indicate the correct USB COM port has been selected). Then enter the manager password (default 123456) and press CONNECT.

Once fully connected, all of the options should be active. You can now change settings in the top half of the screen.

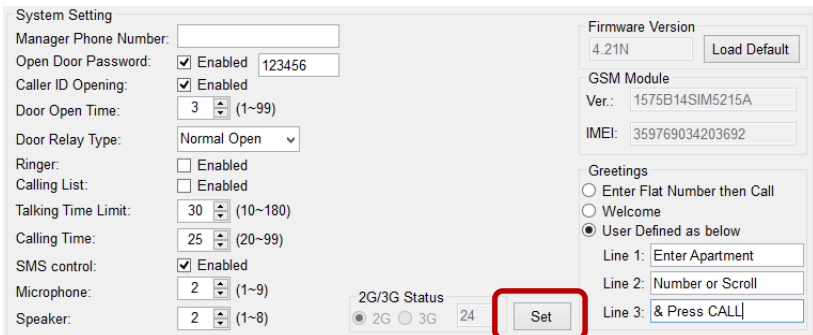

Manager Phone: This can be set for a security guard or building manager to receive assistance calls from the intercom.

Open Door Password: This is the master door access password for the keypad. Note: This feature **MUST** be **ENABLED** if subscribers are to be able to use their own individual codes.

Caller ID Opening: Enable this to allow subscribers to gain access by calling the intercom from their cell phone.

Door Open Time: This sets the relay on time.

Door Relay Type: Select between Normally Closed and Normally Open.

Ringer: If enabled, the intercom will emit a ringing tone when someone calls it from a cell phone.

Calling List: Enable this to allow visitors to scroll list of names on screen.

Talking Time Limit: Adjust this to restrict the max talking time on a call.

Calling Time: Adjust this to prevent the unit ringing a number too long and the call being answered by the users voicemail.

SMS Control: Enable this to allow SMS programming and SMS relay control.

Microphone: Adjust microphone sensitivity gain. Reduce as low as possible to prevent feedback.

Speaker: reduce speaker volume as low as possible or increase for noisy environments.

Greetings: Select **USER DEFINED**, and type your own custom screen instructions, e.g. "Enter Apartment Number, or Scroll & Press **CALL**".

Note: After adjusting any of these settings, press **SET** button as shown to upload the changes to the device.

The bottom half of the screen is related to entering subscribers or residents.

Subscriber loading

subscribers.txt

Subscriber
 Authorized

100242,Mr Thompson,987654321,123456789,,8888,0
100243,Mr John,987654321,123456789,,6666,0
100244,Mr Jones,987654321,123456789,,5656,0
100245,John Connor,123456789,,3456,0
100246,The Smiths,5559995555,9995559999,123456789,2020,0
100247,Mr&Mrs Jackson,123456789,987654321,,5555,0

ID	Name	Phone 1	Phone 2	Phone 3	Code	<input type="checkbox"/> Inhibit
100247	Mr&Mrs Jackson	123456789	987654321		5555	<input type="checkbox"/>

Open: Use this to open a pre-saved file of subscribers on your PC, edit the list and then upload to the intercom.

Save: Use this to save a file on your PC as a backup in the event of system failure on site.

Upload: Press to upload the list to the intercom.

Download: Use this to download all subscribers saved on the intercom to the PC ready for editing.

Subscriber: Select this to add residents. (For US customers you may need to store numbers with long distance 1 prefix at the beginning of the number for caller ID function to work). Note: Maximum 15 characters for subscriber family name.

Authorized: Select this to add visitors who can open the door with their phone. Note that subscribers must have different ID numbers from Authorized users. Do not duplicate ID numbers.

Add: Press to add another subscriber to the list.

Edit: Select the subscriber / resident then press EDIT to highlight the boxes along the bottom, then edit the details as required.

Delete: To delete a subscriber.

Inhibit: Disable a subscriber.

Note: after subscribers / residents are added, deleted or edited, be sure to upload to the device and wait until complete. Then press disconnect, unplug the USB and check if the changes have been implemented.

Using the intercom

This cellular intercom can dial up to 4 numbers in sequence for any call button when pressed..

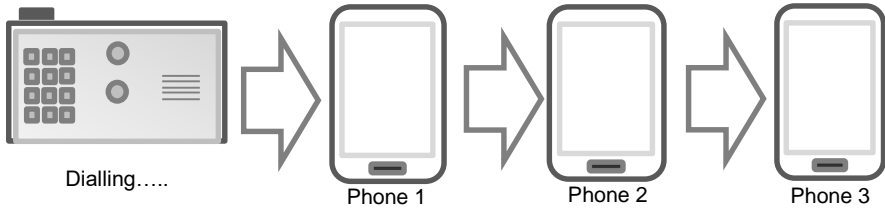

Any user receiving the call can answer, speak to the visitor, and press the following digits on their mobile or fixed line telephone to control the relay on the device...

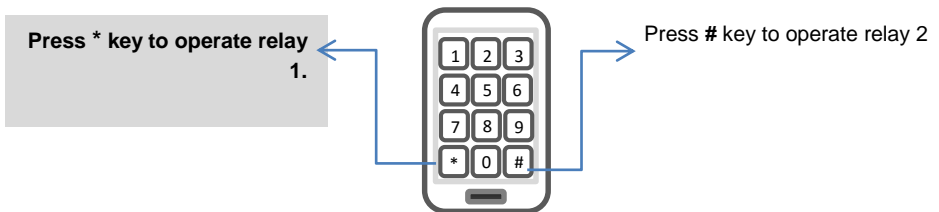

open door 1 momentary	*
open door 2 momentary	#
open door 1 relay hold	1
open door 2 relay hold	2
release door 1 relay	4
release door 2 relay	5

Control by SMS

If the feature is activated, this intercom allows the user to send SMS commands to control the relays as follows...

Relay 1

123456#44#1# - Relay momentary trigger.
123456#44#1,1# - Relay latch ON or hold ON
123456#44#1,0# - Relay unlatch or switch OFF.

Relay 2

123456#44#2# - Relay momentary trigger.
123456#44#2,1# - Relay latch ON or hold ON.
123456#44#2,0# - Relay unlatch or switch OFF.

Door Release by Using the Keypad To Gain Entry via the Keypad

To open door 1 momentary	C + access code + A
To open door 2 momentary	C + access code + B
To open door 1 relay and hold	C + access code + C + 1
To release door 1 relay	C + access code + C + 4
To open door 2 relay and hold	C + access code + C + 2
To release door 2 relay	C + access code + C + 5

Using the Optional App

Android and iPhone users can download a free optional BFT app called **Cell Box PLUS**.

This app performs 2 main functions..

- Speed dials your intercom when the trigger button is pressed.
- Sends SMS messages to latch and unlatch the relay.

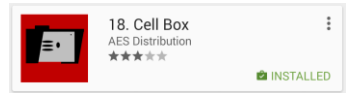

Once the app is installed, you will need to decide on and enter names for each of the buttons.

Note: There are 2 screens, one for each relay.

Android App Setup

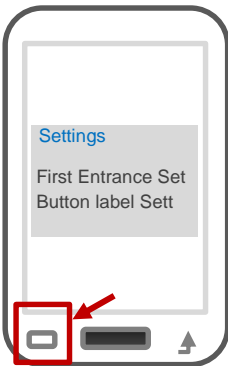

On Android, press the settings button on the device (bottom left) and the settings options will appear.

You can use these options to name each entrance, gate or output, and then name the button functions. For example, if relay 1 is connected to automatic gates, you might choose to name the main momentary trigger button as "VEHICLE OPEN", or "MAIN GATE". For the latching buttons, you may decide to name them for example "Hold Gate", or "Latch Gate". The phone number of the intercom and the SMS message strings also need entered into the app settings.

Using Android App

Main Trigger button

Use this to speed dial intercom and momentary trigger Relay 1.

Latch Relay Button

Sends a pre-configured SMS to latch on relay 1. Can be used to hold open gates or door.

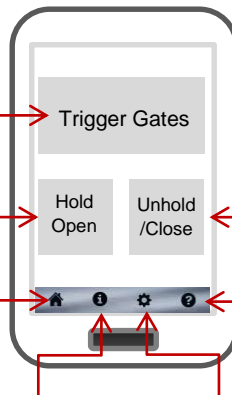

Un-Latch Relay Button

Sends a pre-configured SMS to unlatch relay 1 if it has previously been latched. Can be used to allow gates to close

Status features

Enter new screen to check signal strength, stored numbers, gate or door status.

Info screen

Information about manufacturer.

Settings screen

Setup screen, to enter sim card number of intercom & SMS strings.

Note: Check reception, gate status and stored number features on this app do not work with this model of intercom.

iPhone App Setup

On iPhone the user is also required to enter button labels, the intercom phone number and the default message strings to perform the latch and unlatch functions. To do this, press the label button shown below.

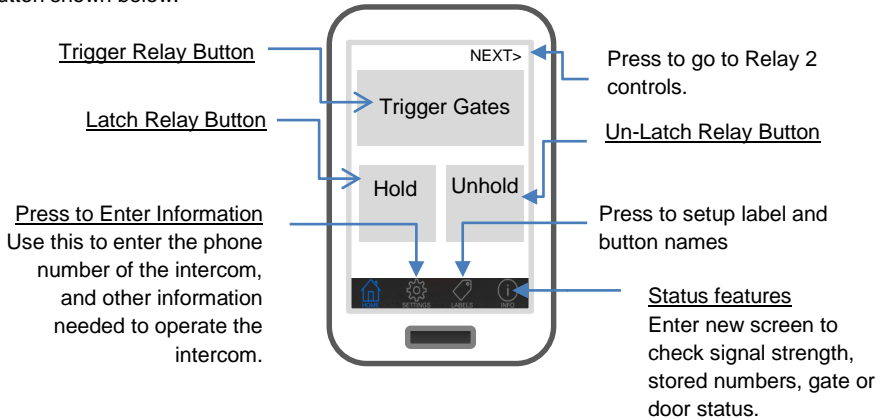

Note: For site security, it is recommended that only the building manager has the ability to latch open the gates. Only the master passcode (default 123456) will allow the latch open SMS text string to work. If it is required for other users to have this feature, the text strings for hold open can be copied from above SMS section and entered into the app settings screen.

However care must be taken when using this feature. If a user latches open the gate, only they will know this has been done. This could cause a situation where other users think there is some problem with the gate and call the engineer.

Maintenance of the Intercom

The intercom SIM card will need topped up occasionally if it is a pre-pay casual SIM card. It is recommended that you register this SIM card on the provider's web site. You can register card payment details. Many networks offer an auto top up feature, which means they will automatically top up your intercom when the balance runs low.

The stainless steel can dull or discolour over time in weather conditions. This can be polished with a suitable stainless steel cleaner.

Troubleshooting guide

Q. The unit will not power up. No LEDs on.

A. Check power supply voltage at intercom is within 23.5-24.5v DC. Cable length from PSU to intercom should be less than 20 feet if possible.

Q. The unit powers up but is not showing network reception or will not respond to SMS.

A. This means the unit is not able to detect the network for some reason.

-Power off the unit, remove the SIM and check it in a mobile phone to verify it can make a call and has calling credit.

-Disable any PIN code request if active on the SIM card.

-Check the SIM is a standard voice capable SIM. If you are unsure, contact your SIM card provider to verify. Frequency of operation should be any one of international quad band standards, 850 / 900 / 1800 / 1900 MHz.

-Check the reception is good. Poor reception is not sufficient.

-Check that the cable from power supply to intercom is within specification and that the cable thickness is 1.5mm or 14 gauge. Alarm, CAT5 or thin gauge cable is not sufficient.

-Power off, remove the SIM, use fine sand paper to lightly sand the SIM pads and contacts on the GSM unit, lightly bend the contacts upwards so that they make better contact with the SIM and try again.

Q. The unit calls the first number, but there is not enough time to answer before it diverts to the next number.

A. Increase the calling time as per programming instructions.

Q. The unit calls the first number but voicemail comes on before it can ring the second number.

A. Decrease the calling time as per programming instructions.

Q. The caller ID part does not work.

A. Be sure the feature is activated by turning on caller ID opening feature.

-For US customers, ensure the numbers have been entered with a leading 1. If this does not work, try again without the leading 1.

-If the caller withholds their phone number, this feature will not work.

Q. There is no audio from the gate, but the person at the gate can hear ok.

A. This can be due to low reception or excessively long power cables.

-Check reception level on site.

-Change SIM card if necessary to another network which may have better coverage.

-Purchase a high gain antenna.

This may also be caused by a defective microphone, water on a microphone from a sprinkler for example, or dirt/insects blocking the microphone hole. If reception is optimum and the problem persists, contact your supplier or installer.

Q. The audio quality that can be heard on the remote telephone is poor or humming (buzzing).

A. A small amount of GSM buzz can be considered normal on GSM intercoms, but not so much that causes inability to hear the person speaking. This can be caused by the GSM antenna being mounted too close to the speech panel or not mounted high enough, or poor power cables being too long or thin.

-Try earthing the speech panel chassis to 0V of the power supply.

-This is also a symptom of poor reception. Try above steps on checking and improving reception.

Q. The keys do not work when the intercom calls a phone.

A. Check if you can hear the relay clicking at the gate when the keys are pressed during a call. If it can be heard, then the system is working, check wiring between the relay and the lock or gate panel. If the relays do not make a clicking sound, then check this feature on a different mobile cell phone or landline. If it works on a different phone, check the settings on the phone in question under DTMF tones.

Failure of DTMF tones to operate correctly is also a symptom of low reception or insufficient power cabling. Check steps above on improving reception or addressing the power problem.

Also check that the relays are not already latched by SMS. Try sending unlatch command by SMS and then try again.

Q. The system was operating the gates fine, but now it will not trigger the gates.

99% of the time, this is caused by the user accidentally latching the relay. This latches the output relay permanently on. Send the unlatch SMS command and try again.

Q. The unit no longer calls out to phones but I can make a call to it from my phone.

A – Check there is balance on the SIM card.

A – Switch off the power, remove the SIM, put it into a phone, and check that a call can be made from a phone. This will verify if the SIM is still working and in service.

Change History

Key:

P = Panel version H = Hardware PCB version S = Software version

Version			Reason for change	Date
P	H	S		
1	1	4.18	2 relay version, keypad code for each user added.	
		4.21	Latching relay feature added.	30-July-15
		4.22.n	Bug fix on call lists	1-Sept-15
		4.24.n	Bug fix on wrong access code	9-Mar-16
2	1	4.24.n	Machine window added	
3	2	(4)4.28.k	Etching, lit keypad & firmware for lit keypad	16-May-16

BFT Americas

6100 Broken Sound Parkway N.W. Suite 14, Boca Raton, FL 33487



www.bft-usa.com

Toll Free: 877-995-8155

Office: 561-995-8155

Fax: 561-995-8160